

 Cortinadecor

ESTORES SIN TALADRAR

GUÍA DE INSTALACIÓN

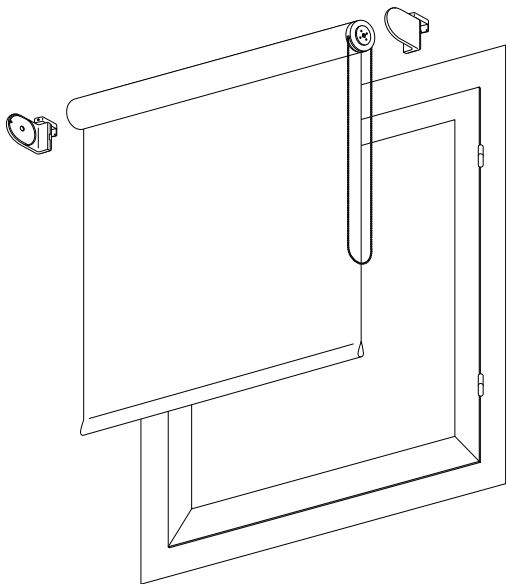

Comprobar piezas

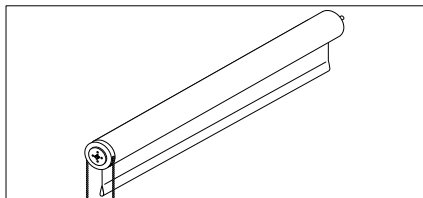

Estor

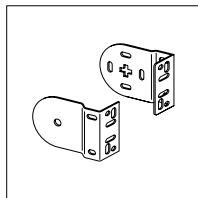

Soportes

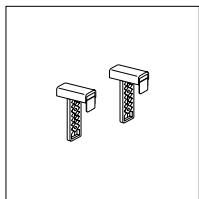

Ganchos

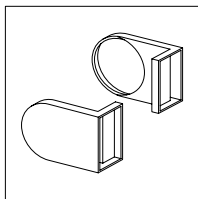

Embellecedores

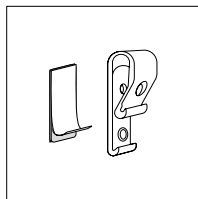

**Seguridad infantil
y pegatina**

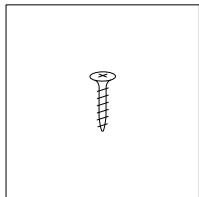

Tornillos

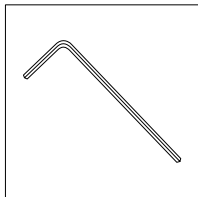

Llave allen

1 | Preparamos los soportes

Primer soporte

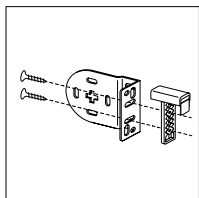

Atornillar

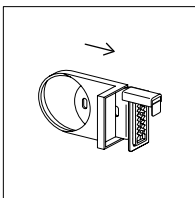

Encajar

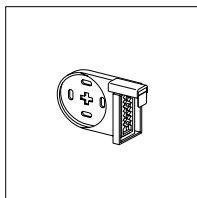

Segundo soporte

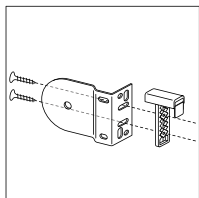

Atornillar

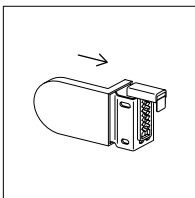

Encajar

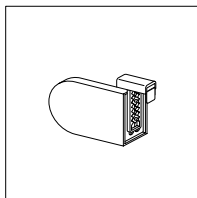

Si tus soportes y ganchos no van unidos de fábrica sigue estos pasos: **Posicionamos** y **atornillamos** con los tornillos el gancho al soporte. **Encajamos** el embellecedor al soporte. **Repetimos** la etapa para el segundo soporte.

2 | Colocamos los soportes

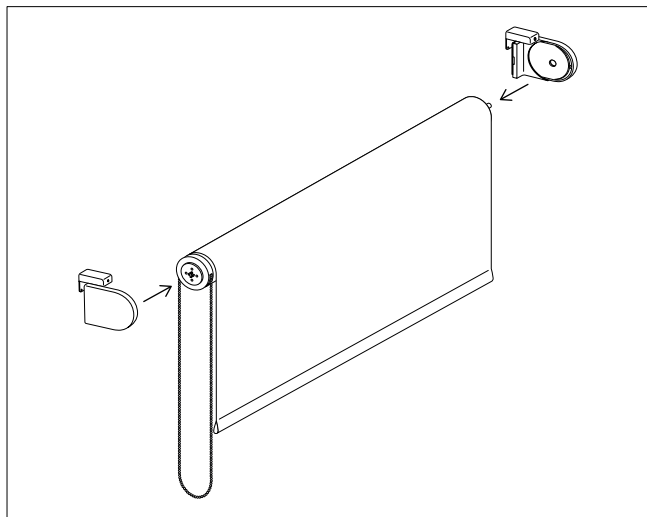

Colocar

Colocamos los dos soportes de cada lado del estor.

3 | Fijamos el estor

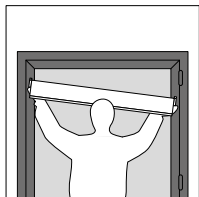

Posicionar

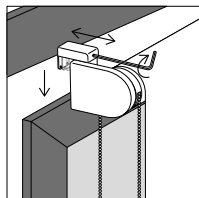
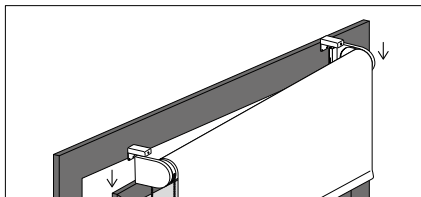

Posicionar

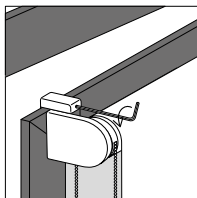

Apretar

Abrimos la ventana. **Sujetamos** los soportes de cada lado y **colocamos** el estor centrada a la ventana. A continuación, los soportes **se aprieta** con la ayuda de la **llave allen** a la hoja de la ventana.

4 | Seguridad infantil

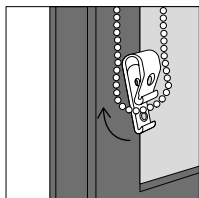

Introducir

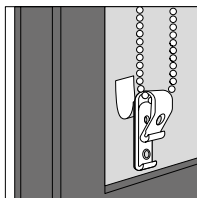

Despegar

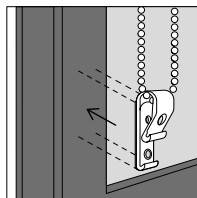

Pegar

ADVERTENCIA

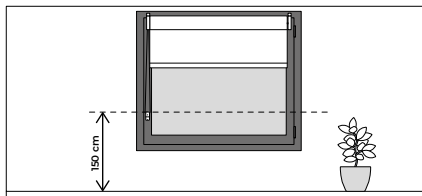

Medir

Introducimos la cadena en la seguridad infantil, **despegamos** el papel de protección de la pegatina y **pegamos** la seguridad infantil en el marco de la ventana. **La altura de la cadena debe quedar instalada como mínimo a 150 cm del suelo.**

Atención al cliente

soporte@cortinadecor.com

966 181 033

www.cortinadecor.com